

BUXIE - 1124D

ULTRA COMPACT - 575 W MSD



- **Type:** Followspot
- **Source:** 575 W MSD
- **PSU:** Electronic - hot restrike
- **Optics:** 10.5° to 22.5° zoom

Followspot

The little spot with the powerful punch

Buxie's 2,000-hour, 575 W MSD HR lamp, gives the security of hot restrike whilst its quiet electronic PSU is fixed to the yoke for space saving. Buxie's compact dimensions make it perfect for use as a truss spot or when space is at a premium.

Features

- **Fully closing iris:** removable for fast, easy replacement
- **Universal gobo holder:** "A" size glass and metal gobo
- **Smooth dimmer shutter:** retains flat beam and colour temperature when dimming
- **Internal glass filter holder:** long term use of durable coloured, dichroic or textured glass
- **Colour changer:** 6-way, 'push/pull' colour changer system for simultaneous use of multiple filters
- **Easy focus reference:** graduated scale on side of the unit; fast and easy refocusing

Optical

- **SX optical system:** double condenser optics for exceptional optical quality
- **Variable zoom optics:** sharp focus at every beam angle. Independent control of image size and focus.

Construction

- **Made in France :** fully manufactured in Robert Juliat premises retaining complete control over all aspects of quality
- **Bodywork:** strong sheet metal construction for durability
- **Moving parts:** smooth at all times, even when hot
- **Captive knobs and handles:** additional security when working at height or in transit
- **Easy access to all parts:** easy cleaning, re-lamping and maintenance
- **Removable assemblies:** fast-plug cable connectors and complete component assemblies (mirror, condenser set and lamp house assembly) save maintenance and cleaning time

Picture:1124D

DSEN097_1124D - 13/09/2021

Robert Juliat reserves the right to change or alter any of the items detailed on this page, to increase or improve manufacturing techniques without prior notice.

Robert Juliat S.A.S., 32 rue de Beaumont, 60530 Fresnoy-en-Thelle - France
Telephone : +33 (0)3 44 26 51 89 - fax : +33 (0)3 44 26 90 79 - info@robertjuliat.fr
www.robertjuliat.com



ROBERT JULIAT

Source



- **Lamp type:** Discharge
- **Power:** 575 W
- **Socket:** G22
- **Hot re-strike:** yes

| Admissible lamps | Power * | Lumen output* | Colour temperature* | Life* | CRI* (min) |
|-----------------------|---------|---------------|---------------------|---------|------------|
| MSD 575W HR (Philips) | 575 W | 46 000 lm | 6000K | 2 000 h | 75 |

(*) manufacturer's data

Optics

Characteristics

- **Type:** Zoom
- **Beam range:** 10.5° to 22.5°
- **Focal length:** 189 - 408 mm

Gel filter

- **Shape:** Circle
- **Standard size:** 165 mm (6.5 in)

Gobo

- **Size:** A
- **Material:** Metal
Glass

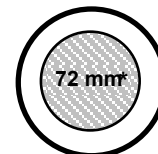

100 mm
*Maximum image size

Photometrics

with MSD 575W HR (Philips) source

• Optics @ 10.5°

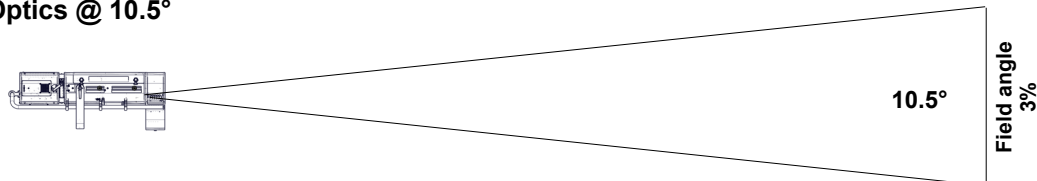

Beam intensity
338 000 cd

| | | | | | | |
|---------------------|-----------|-----------|---------|---------|---------|---------|
| Distance | 10 m | 15 m | 20 m | 25 m | 30 m | 35 m |
| Diameter | 1.8 m | 2.8 m | 3.7 m | 4.6 m | 5.5 m | 6.4 m |
| Illumination | 3 400 lux | 1 550 lux | 850 lux | 550 lux | 380 lux | 280 lux |

| | | | | | | |
|---------------------|--------|--------|---------|---------|---------|---------|
| Distance | 35 ft | 50 ft | 65 ft | 80 ft | 100 ft | 115 ft |
| Diameter | 6.4 ft | 9.2 ft | 11.9 ft | 14.7 ft | 18.4 ft | 21.1 ft |
| Illumination | 280 fc | 140 fc | 85 fc | 55 fc | 34 fc | 26 fc |

• Optics @ 22.5°

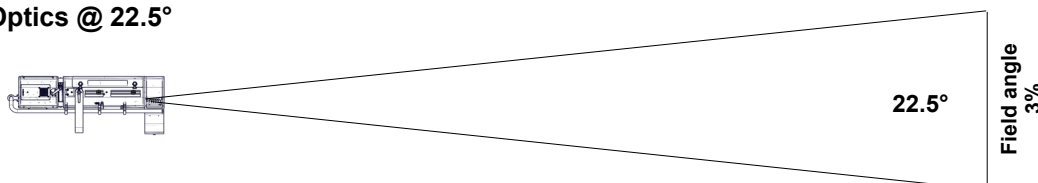

Beam intensity
113 000 cd

| | | | | | | |
|---------------------|-----------|---------|---------|---------|---------|--------|
| Distance | 10 m | 15 m | 20 m | 25 m | 30 m | 35 m |
| Diameter | 4 m | 6 m | 8 m | 9.9 m | 11.9 m | 13.9 m |
| Illumination | 1 150 lux | 510 lux | 290 lux | 190 lux | 130 lux | 95 lux |

| | | | | | | |
|---------------------|---------|---------|---------|---------|---------|---------|
| Distance | 35 ft | 50 ft | 65 ft | 80 ft | 100 ft | 115 ft |
| Diameter | 13.9 ft | 19.9 ft | 25.9 ft | 31.8 ft | 39.8 ft | 45.7 ft |
| Illumination | 95 fc | 46 fc | 27 fc | 18 fc | 12 fc | 9 fc |

Dimensions and weight

Unit

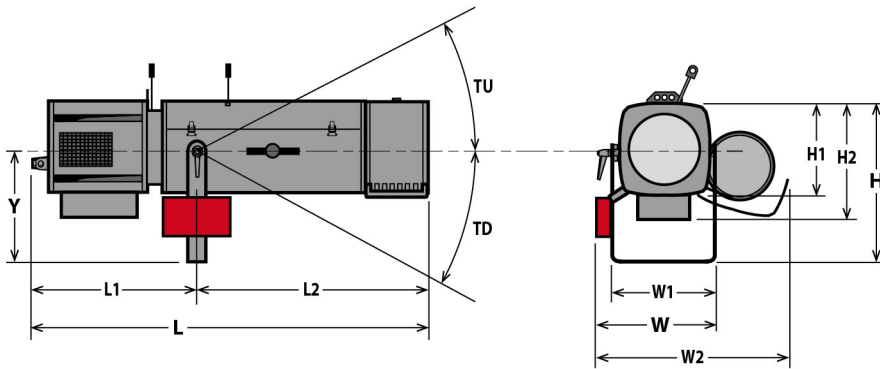

Weight: 16 kg (35.2 lbs)
with PSU

| Height | Length | Width | Yoke | Tilt |
|----------------------|----------------------|----------------------|---------------------|---------|
| H= 390 mm (15.4 in) | L= 920 mm (36.2 in) | W= 330 mm (13 in) | Y= 283 mm (11.1 in) | TU= 45° |
| H1= 208 mm (8.2 in) | L1= 350 mm (13.8 in) | W1= 208 mm (8.2 in) | | TD= 45° |
| H2= 265 mm (10.4 in) | L2= 570 mm (22.4 in) | W2= 490 mm (19.3 in) | | |

Shipping

PSU

• **Weight :** 22 kg (48.4 lbs)

Width: W= 71 mm (2.8 in)

• **Volume :** .16 m³ (5.65 ft³)

Height: H= 162 mm (6.4 in)

Length: L= 245 mm (9.6 in)

Weight: 2.8 Kg (6.2 lbs)

Installation

• **Minimum distance to illuminated surface:** 2.5 m (8.2 ft)

• **Operating position:**

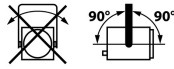

Warranty

• **Fixture: 2 years**

See General Sales Condition on website

Approvals



Construction

- **Housing:** Steel sheet - Aluminium
- **Colour:** Black
- **Cooling:** Low noise fan
- **Maximum ambient temperature (Ta):** 40°C (104°F)
- **Maximum case temperature (Tc):** 260°C (500°F)
- **Total heat dissipation:** 2 458 BTU/h
- **Ingress Protection (IP) rating:** IP20

- **PSU housing:** Steel sheet - Aluminium
- **PSU colour:** Black
- **PSU cooling:** Fans
- **PSU maximum ambient temperature (Ta):** 40°C (104°F)
- **PSU maximum case temperature (Tc):** 65°C (149°F)

Electrical compatibility

- 220/230 V - 50 Hz
- 245 V - 50 Hz
- 110/120 V - 60 Hz
- 208 V - 60 Hz
- 220/230 V - 60 Hz
- 100 V - 50 Hz
- 100 V - 60 Hz
- Selector: automatic detection

Power input



- **Type:** attached power cord
- **Cable:** H07RNF 3G1.5
- **Length:** 3 m (9.8 ft)
- **Power connector:** CEE 7/7 (2P+E NF/Schuko)

Power consumption

| Voltage | Frequency | Current | Power | Power factor |
|---------|-----------|---------|-------|--------------|
| 230 V | 50 Hz | | 720 W | |
| 120 V | 60 Hz | | 720 W | |
| 90 V | 50 Hz | | 720 W | |

Power Supply Unit

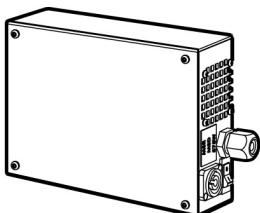



- **PSU:** On yoke - Electronic PSU - Flicker free with PFC
- **Lighting unit / PSU cable:** Cable attached to unit - length: 1,5 m (4,9 ft)
Type: 3G1,5 HO7RNF with Neutrik PowerCon® (ref. NAC3FCB) connector
- **Maximum distance between lighting unit and PSU:** 25 m (82 ft)
- **Control:** Local
- **Protection:** Mains: 10A 5x20 T fuse /















Model





| | |
|--------------|--|
| 1124D | 575 W MSD Followspot - 1124D Buxie - 10.5/22.5° - Electronic PSU |
|--------------|--|

Options

| | | |
|-----------------|--|---|
| PCP1716A | 16A blue 2P+E 6h IEC60309 power connector |  |
| FC1124 | Flight-case for Ultra Compact range / GT stand - Dim: 1210x600x560mm - Weight: 35 Kg |  |

Accessories

| | | |
|--------------------|--|---|
| IS750 | Full closing iris with holder - Poids: 0.35 Kg 2 included |  |
| PF1114 | Ø165 mm metal filter holder 6 included |  |
| SGUX | Universal "A" size gobo-holder (metal, glass, frosted glass) 1 included |  |
| M165TP | 6 ways "push/pull" colour changer - Poids: 2.09 Kg 1 included |  |
| MSD 575W HR | MSD 575W HR - Philips G22 575W 2000h 6000K lamp |  |
| GT1000 | Tripod stand - SWL: 40 Kg - max. height: 1550 mm - Poids: 9.27 Kg |  |
| GT800 | Tripod stand - SWL: 40 Kg - max. height: 1550 mm - Poids: 7.98 Kg |  |
| T1000 | TV spigot with followspots swivel head - Poids: 1.82 Kg |  |
| T4000 | Followspot mount for Ø50mm pipe (suspension or overhead) - SWL= 100 Kg - Poids: 4.88 Kg |  |
| CAV600A | Double slot front cassette for 180x180mm accessories - Poids: 0.43 Kg |  |
| T/1650SXCW | SULLY 115W LED compartment with potentiometer - Cool White - 3 meter power cable with CEE 7/7 (2P+T NF/SCHUKO) connector - Poids: 2.27 Kg |  |
| T/1650SXWW | SULLY 115W LED compartment with potentiometer - Warm White - 3 meter power cable with CEE 7/7 (2P+T NF/SCHUKO) connector - Poids: 2.27 Kg |  |
| T/600SX | Lamp compartment for 1000/1200W tungsten GX9,5 lamps - 3 meter power cable with CEE 7/7 (2P+T NF/SCHUKO) connector - Poids: 1.36 Kg |  |
| T/600VSX | Lamp compartment for 1000/1200W tungsten G22 lamps with fan - 3 meter power cable with CEE 7/7 (2P+T NF/SCHUKO) connector - Poids: 2.03 Kg |  |

| | | |
|-------------------|--|---|
| VD120 | 120x120mm frosted glass |  |
| Kit TELRAD | Telrad followspot sight with raiser and universal mounting kit - Poids: 1.23 Kg |  |
| SDUP | Followspot cue sheet holder with universal mounting kit |  |
| FC1124/S | Flight-case for Ultra Compact range / GT stand - Poids: 35 Kg |  |
| W/GT800 | Set of 3 wheels for GT800/1000 stand - Poids: 2.33 Kg |  |